



ATSC
ITU-T J.83
ISDB-T



Version
10.00

June
2004

TV Test Transmitter R&S® SFQ

Digital signals for antenna, satellite and cable

- ◆ Wide output frequency range from 0.3 MHz to 3300 MHz
- ◆ Large output level range for transmission, receiver and module measurements
- ◆ Standard DVB, DTV signals and FM satellite signals
- ◆ Several standards in one unit
- ◆ Flexible input interfaces
 - ASI, SPI, SMPTE310
- ◆ Output and input for I/Q signals
- ◆ Internal noise generator for high-precision C/N settings
- ◆ Internal BER measurement facility for all digital modulation modes
- ◆ Internal fading simulator
 - 6 or 12 paths
 - Profiles: Constant Phase, Rayleigh, Rice, Pure Doppler, Lognormal
 - Predefined and user-defined profiles
 - Fading output power selectable for sum signal or main path
- ◆ Antenna DVB-T
 - 2K and 8K COFDM
 - 6/7/8 MHz bandwidth
 - Hierarchical coding
- ◆ Antenna ATSC
 - 8VSB
- ◆ Antenna ISDB-T
 - Mode 1/2/3 (2k, 4k, 8k)
 - Max. 3 layers (A, B, C)
 - 13 segments (settable number for each layer)
 - DQPSK, QPSK, 16QAM, 64QAM
- ◆ Cable DVB-C
 - Selectable QAM: 16, 32, 64, 128, 256QAM
- ◆ Cable J.83-B
 - Selectable QAM (64, 256QAM)
- ◆ Satellite DVB-S, DVB-DSNG
 - QPSK, 8PSK, 16QAM
- ◆ Satellite FM
 - PAL, SECAM, NTSC
 - FM and ADR sound subcarrier



ROHDE & SCHWARZ

Basic models – options for DVB/8VSB/ISDB-T/J.83-B, transmission simulation

Basic models

- ◆ DVB-T: R&S®SFQ02 + R&S®SFQ-B10
- ◆ ATSC: R&S®SFQ02 + R&S®SFQ-B12
- ◆ ISDB-T: R&S®SFQ02 + R&S®SFQ-B26
- ◆ DVB-C: R&S®SFQ02 + R&S®SFQ-B21
- ◆ J.83-B: R&S®SFQ02 + R&S®SFQ-B13
- ◆ DVB-S/-DSNG: R&S®SFQ02 + R&S®SFQ-B23
- ◆ FM: R&S®SFQ02 + R&S®SFQ-B2

DVB/VSB options

- ◆ Input interface (ASI, SPI, SMPTE310; settable symbol rate, accurate data clock)
- ◆ DVB-T coder
- ◆ Hierarchical coding for DVB-T coder
- ◆ ATSC/8VSB coder
- ◆ ISDB-T coder
- ◆ DVB-C coder
- ◆ J.83-B coder
- ◆ DVB-S/-DSNG coder
- ◆ I/Q output/input

Transmission simulation

- ◆ Fading simulator (6 or 12 paths)
- ◆ Noise generator
- ◆ BER measurement

Broadband FM options

- ◆ Broadband FM modulator
- ◆ FM sound subcarrier with internal audio generators
- ◆ ADR sound subcarrier with internal MUSICAM generators

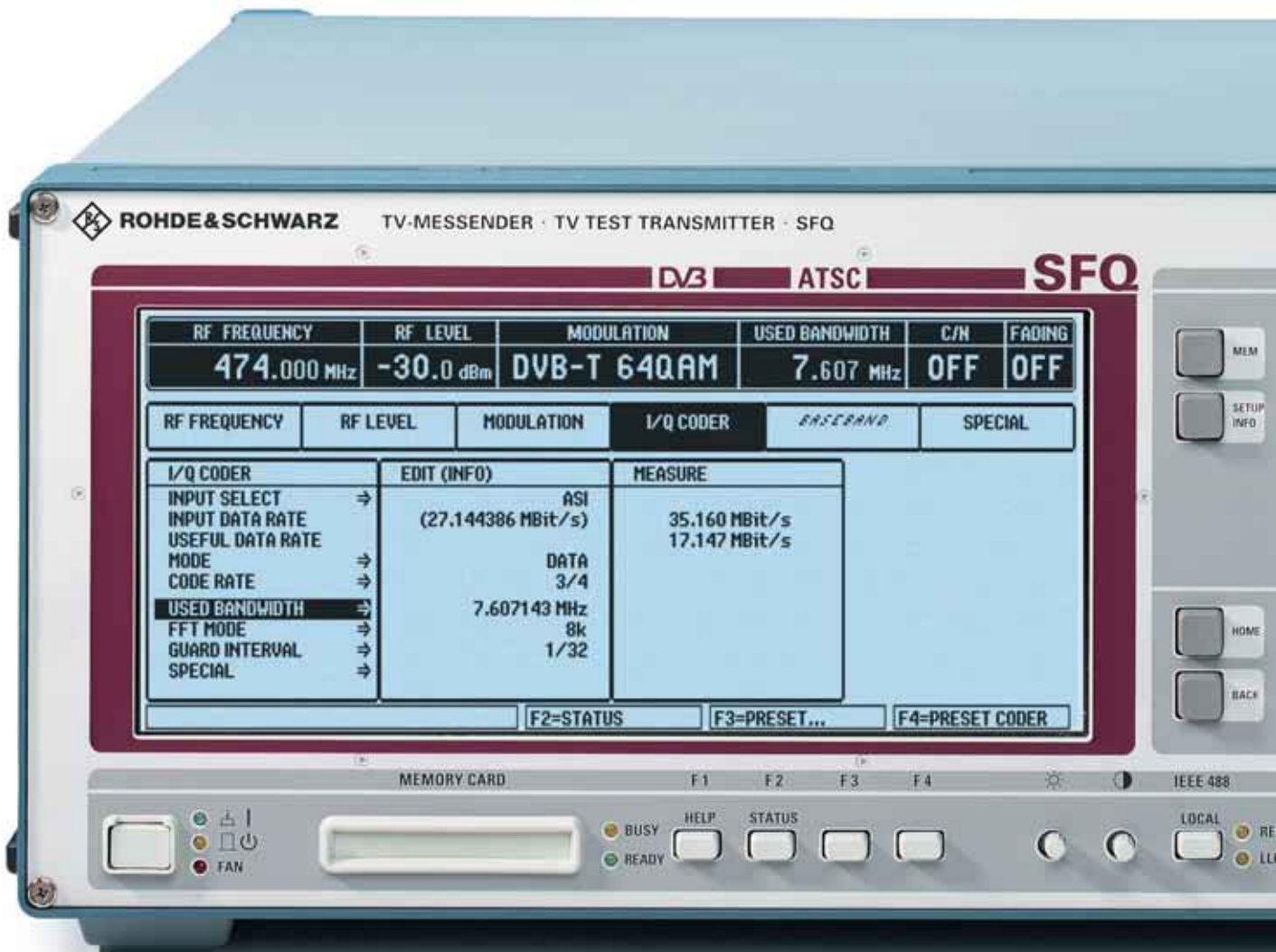

Basic features

- ◆ Frequency range 0.3 MHz to 3.3 GHz
- ◆ Large level range –99.9 dBm to +13 dBm
- ◆ Simple, user-friendly hardkey and softkey control
- ◆ Large display with all important parameters in headline
- ◆ Status menu for supplementary information
- ◆ User-definable transmitter tables
- ◆ Storage of instrument settings internally and on memory card
- ◆ Online help
- ◆ IEC625/IEEE488 bus, RS-232-C interface
- ◆ Modular design
- ◆ Software update via RS-232-C interface (or memory card)



General

The TV Test Transmitter R&S®SFQ is a complete solution for testing digital TV links and receivers. The open-end software and modular hardware make the R&S®SFQ future-proof. The standards for DVB-T, DVB-S/DVB-DSNG, DVB-C, J.83-B, ATSC/8VSB and ISDB-T are fully complied with. Owing to its adaptability to future system changes, the R&S®SFQ is a useful and rewarding investment for your launch onto the digital TV market.

Moreover, the R&S®SFQ also processes analog frequency-modulated satellite signals in line with PAL, SECAM, NTSC standards. The sound signals are transmitted using analog FM and digital ADR sound subcarriers.

The test signals produced are of high precision and comply with the standards, but they can also be varied and provided with predefined errors to determine the performance of your products at their limits. The reproducible simulation of real transmission conditions by means of the noise generator and the fading simulator enables the specification of modules under test.

Applications

Because of its high signal quality and versatile parameters variations, the R&S®SFQ is ideal as a source for digital terrestrial signals (DVB-T, ATSC and ISDB-T), for testing satellite (DVB-S/-DSNG and FM) and digital cable links (DVB-C, J.83-B), as a standard-signal generator in development, as a reference in quality monitoring, EMC labs, inspection and test centers and for use in production. The output frequency range allows the R&S®SFQ to be used as a back-channel generator and covers future extensions of the satellite IF range.

Operational parameters (e.g. roll-off, puncturing rate or QAM mode) can easily be varied. For laboratory applications, values outside those defined in the standard can be selected. For special measurements, e.g. DVB-T, it is possible to switch off modulation, individual carriers or groups of carriers. Sweep can be performed over the complete RF range.

A shift function for frequency, level and C/N makes it possible to determine the functional limits of the DUT, compensate for external matching pads, adjust two units to give exactly the same output signal, etc. The advantage is that the output signal can be changed as required while the standard/nominal value continues to be displayed on the R&S®SFQ.

The analog R&S®SFQ supplies frequency-modulated satellite signals conforming to standards. Various TV standards can be selected and up to six sound subcarriers (FM and ADR) can be integrated. In addition, external sound subcarriers can be applied. Operational parameters are in line with standards; parameters such as amplitude, frequency and deviation are variable. Signals such as noise or energy dispersal can be added. It is thus possible to test satellite links and receivers with the aid of standard signals and to check the response to nonstandard signals.

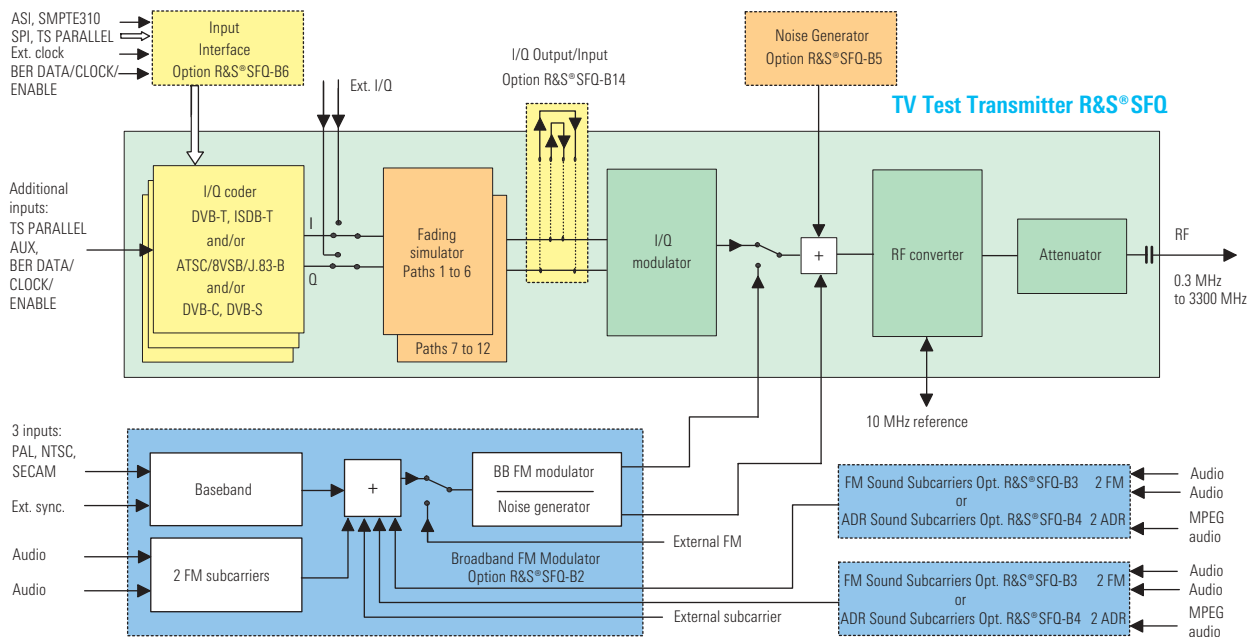

Block diagram of the TV Test Transmitter R&S®SFQ with available options

R&S®SFQ models		
Models	Description	Free slots for options
R&S®SFQ02 + option R&S®SFQ-B10	TV Test Transmitter for DVB-T	5
R&S®SFQ02 + option R&S®SFQ-B12	TV Test Transmitter for ATSC/8VSB	5
R&S®SFQ022 + option R&S®SFQ-B26	TV Test Transmitter for ISDB-T	5
R&S®SFQ02 + option R&S®SFQ-B21	TV Test Transmitter for DVB-C	5
R&S®SFQ02 + option R&S®SFQ-B13	TV Test Transmitter for J.83-B	5
R&S®SFQ02 + option R&S®SFQ-B23	TV Test Transmitter for DVB-S/-DSNG	5
R&S®SFQ02 + option R&S®SFQ-B2	TV Test Transmitter for Broadband FM	3

DVB/8VSB/ISDB-T/J.83-B options			
Options	Description/application (always state the R&S®SFQ serial number when ordering an R&S®SFQ option)		Required slots
R&S®SFQ-B6	Input Interface	ASI, SPI input with stuffing, SMPTE input, enhanced clock accuracy of internal signals	0
R&S®SFQ-B10	DVB-T Coder	Included in model .20 ¹⁾ (see options R&S®SFQ-B3 and R&S®SFQ-B4)	1
R&S®SFQ-B16	DVB-T/ Hierarchical Coding	Only in conjunction with R&S®SFQ model .20 ¹⁾ or option R&S®SFQ-B10	0
R&S®SFQ-B12	ATSC/8VSB Coder (HW + FW)	Included in model .30 ¹⁾ , not in conjunction with R&S®SFQ-B13	1
R&S®SFQ-B8	ATSC/8VSB (FW)	Included in R&S®SFQ-B12 Only in conjunction with option R&S®SFQ-B13	0
R&S®SFQ-B13	ITU-T J.83-B Coder (HW + FW)	Only in conjunction with option R&S®SFQ-B6, not in conjunction with R&S®SFQ-B12	1
R&S®SFQ-B9	ITU-T J.83-B (FW)	Included in R&S®SFQ-B13 Only in conjunction with options R&S®SFQ-B12 and R&S®SFQ-B6	0

DVB/8VSB/ISDB-T/J.83-B options (contd.)

Options	Description/application (always state the R&S®SFQ serial number when ordering an R&S®SFQ option)		Required slots
R&S®SFQ-B15	DVB-C/DVB-S Coder	No longer available, included in model .10 ¹⁾	1
R&S®SFQ-B21	DVB-C Coder (HW + FW)	Not in conjunction with R&S®SFQ-B15, R&S®SFQ-B23	1
R&S®SFQ-B22	DVB-C (only FW)	Only in conjunction with R&S®SFQ-B23, included in R&S®SFQ-B21	0
R&S®SFQ-B23	DVB-S/-DSNG Coder (HW + FW)	Not in conjunction with R&S®SFQ-B15, R&S®SFQ-B21 and R&S®SFQ-B6 model .02	1
R&S®SFQ-B24	DVB-S/-DSNG (only FW)	Only in conjunction with R&S®SFQ-B21, not in conjunction with R&S®SFQ-B6 model .02, included in R&S®SFQ-B23	0
R&S®SFQ-B26	ISDB-T Coder	—	1
R&S®SFQ-B14	I/Q Output/Input	Output/input for external applications (e.g. external modulator) and for signal modification/manipulation (see option R&S®SFQ-B2), not in conjunction with R&S®SFQ-Z5	0

Options for transmission simulation

Options	Description/application (always state the R&S®SFQ serial number when ordering an R&S®SFQ option)		Required slots
R&S®SFQ-B11 model .02	Fading Simulator, paths 1 to 6	Fading simulation for up to 6 paths 2 slots for R&S®SFQ model .10 ¹⁾ delivered before September 1999; serial number of R&S®SFQ must be stated	1
R&S®SFQ-B11 model .04	Fading Simulator, paths 7 to 12	Fading simulation for up to 12 paths; only in conjunction with option R&S®SFQ-B11, model .02	1
R&S®SFQ-B5	Noise Generator	BER vs C/N, measurement of system margins; not in conjunction with option R&S®SFQ-B2	1
R&S®SFQ-B27	Impulsive Noise	Only in conjunction with option R&S®SFQ-B5 (model .04 or higher)	0
R&S®SFQ-Z5	Cable Set Diversity	Not in conjunction with option R&S®SFQ-B14	0
R&S®SFQ-B17	BER Measurement	Only in conjunction with R&S®SFQ model .20 ¹⁾ or with option R&S®SFQ-B10 or with option R&S®SFQ-B6 model >.03	0

BB-FM options

Options	Description/application (always state the R&S®SFQ serial number when ordering an R&S®SFQ option)		Required slots
R&S®SFQ-B2	Broadband FM Modulator	Satellite FM with 2 FM sound subcarriers, noise generator included, not in conjunction with option R&S®SFQ-B5 <u>Restriction in conjunction with option R&S®SFQ-B14:</u> only one video input on front panel available	3
R&S®SFQ-B3	2 FM Sound Subcarriers	2 additional FM sound subcarriers, only in conjunction with option R&S®SFQ-B2 <u>Restriction in conjunction with option R&S®SFQ-B10:</u> sound inputs only for one R&S®SFQ-B3 option <u>or</u> one R&S®SFQ-B4 option	1
R&S®SFQ-B4	2 ADR Sound Subcarriers	2 additional ADR sound subcarriers, only in conjunction with option R&S®SFQ-B2 <u>Restriction in conjunction with option R&S®SFQ-B10:</u> sound inputs only for one R&S®SFQ-B3 option <u>or</u> one R&S®SFQ-B4 option	1

¹⁾ Previous model designations.

DVB: coding and mapping for antenna, satellite and cable

The I/Q coders of the TV Test Transmitter R&S®SFQ encode the applied transport stream for terrestrial transmission via antenna or for satellite or cable transmission in line with standards and condition it so that I and Q (inphase and quadrature) signals are obtained. The R&S®SFQ accepts MPEG transport streams with a packet length of 188 or 204 bytes. The input interfaces are synchronous parallel (TS parallel, SPI) and asynchronous serial (ASI). The input data rate and the symbol rate for DVB-C, DVB-S and DVB-DSNG modulation are selectable. With DVB-T modulation, the channel bandwidths of 6 MHz, 7 MHz and 8 MHz can be selected; their default settings can be varied.

Instead of the external transport data stream (DATA) being used, an internal data source can generate null transport stream packets (NULL TS PACKET, as defined in the DVB Measurement Guidelines), or an unpacketed random sequence (PRBS). The PRBS sequence is also available in packeted form in the null transport stream packets (NULL PRBS PACKET). The R&S®SFQ warns the user if

the input signal fails, the set data rate does not match the incoming one or the USEFUL DATA RATE is too high.

The input data stream is linked to a random sequence, ensuring that the signal energy is evenly distributed (energy dispersal). Energy dispersal can be switched off. The same applies to SYNC BYTE inversion.

Following energy dispersal, a Reed-Solomon coder (204,188) is provided as an outer encoder for forward error correction (FEC). 16 parity bytes are added to the unchanged 188 data bytes of each transport stream packet. These 16 parity bytes form the redundancy that allows eight errored bytes of a frame to be corrected by the receiver. A convolutional interleaver distributes the data so that consecutive bits are separated. Burst errors occurring on the transmission path are split up by the de-interleaver into single errors that can be corrected by the Reed-Solomon decoder. The interleaver, too, can be disabled.

Up to and including the convolutional interleaver, coding is identical for antenna (COFDM), satellite (QPSK, 8PSK, 16QAM) and cable (QAM) transmission. No further

FEC coding is provided for cable transmissions, as in this case interference due to noise, nonlinearities and interruptions is less likely than on satellite links or with antenna transmissions. With cable transmissions, mapping into the I and Q paths is performed next.

For terrestrial transmissions via antenna and for satellite transmissions, additional inner FEC coding is performed after the convolutional interleaver. The procedure, which is known as convolutional encoding, doubles the data rate. Puncturing is carried out next, i.e. certain bits are left out in the transmission according to a defined algorithm, so that the data rate is reduced again.

With DVB-S satellite transmissions, mapping into the I and Q paths is performed at this point. Instead of the convolutional encoder (DVB-S), a pragmatic trellis coding type is used for DVB-DSNG satellite transmission.

For terrestrial transmissions, the signal is made to pass through further FEC stages because of the inherently unfavorable propagation conditions: an inner bit

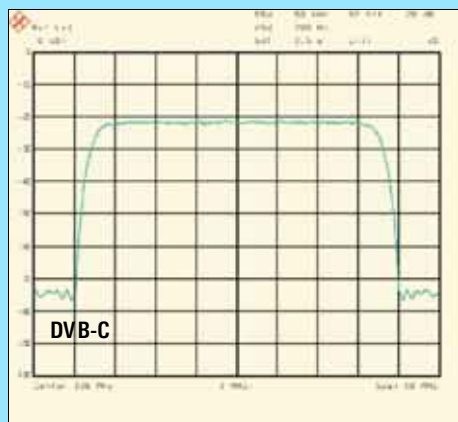

interleaver (at the antenna end) and a symbol interleaver. Next, mapping is performed according to the selected QPSK, 16QAM or 64QAM constellation. After insertion of the pilot and TPS (transmission parameter signalling) carriers in the frame adapter, conversion of the frequency domain to the time domain is effected by an inverse fast Fourier transform, to a 1705 (2K) or 6817 (8K) carrier depending on the selected mode. As a last step, the guard interval is inserted.

Prior to modulation, the spectrum has to be limited by filtering. The roll-off factor (root cosine) can be varied in for DVB-S, DVB-DSNG and DVB-C.

ATSC/8VSB: coding and mapping for antenna

The I/Q coder for 8VSB of the TV Test Transmitter R&S®SFQ encodes the applied transport stream for terrestrial transmission via antenna in line with standards and processes it so that I and Q (inphase and quadrature) signals are obtained.

With 8VSB, the R&S®SFQ accepts MPEG transport streams with a packet length of 188 bytes. The input interfaces are synchronous parallel (TS parallel, SPI), asynchronous serial (ASI) and serial (SMPTE310M).

When using the TS parallel input, an input data rate of 19.3926 Mbit/s ±10% can be attained. Use of the optional input interface yields a USEFUL DATA RATE in a wide range of up to 19.3926 Mbit/s.

The R&S®SFQ warns the user if the input signal fails or if the USEFUL DATA RATE is too high. Instead of the external transport stream (DATA) being applied, an internal data source can generate null transport stream packets (NULL TS PACKET, NULL PRBS PACKET). A SYNC PRBS is implemented for bit error evaluation in receivers. An unpacked random sequence may also be selected. With 8VSB the PRBS sequence can be selected before (PRBS BEFORE TRELLIS) or after the trellis coder (PRBS AFTER TRELLIS). The PRBS sequence is also available in packeted form in the null transport stream packets (NULL PRBS PACKET).

Generation of the standard frame is followed by a randomizer which ensures that energy is evenly distributed in the channel (energy dispersal). The randomizer can be disabled. Following energy dispersal, a Reed-Solomon coder (208, 188) is provided for forward error correction (FEC). 20 parity bytes are added to the unchanged 188 data bytes. Up to ten errors per segment can thus be corrected. A convolutional interleaver changes the position of the individual bytes so that consecutive bytes are separated. Burst errors occurring on the transmission path are split up by the receiver into individual errors that can be corrected by the Reed-Solomon decoder. The interleaver can be disabled. A trellis coder follows for further FEC. The segment sync and the field sync pulses are inserted after the interleaver or trellis coder. The mapper assigns the relevant amplitude steps to the symbols. The pilot used by the receiver for synchronization is also added in the mapper. The pilot amplitude can be modified and switched off. Prior to modulation, the spectrum must be limited by appropriate filtering. The roll-off is permanently set to 0.115 (root cosine).

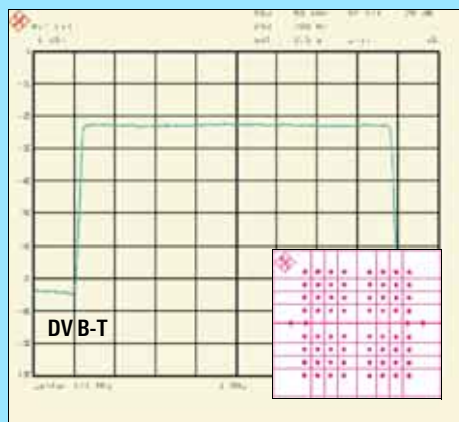

RF FREQUENCY	RF LEVEL	MODULATION	USED BANDWIDTH	C/N	FADING
474.000 MHz	67.0 dBµV	DVB-T 64QAM	7.507 MHz	OFF	OFF
DVB-S QPSK	DVB-C QAM	DVB-T COFDM	ATSC 8VSB	IS EXTERNAL	PRESENG 1/2/3/4
DVB-T COFDM MODULATION		CODER		CODER	
I/Q PHASE ERROR 0 DEG	CARRIER SUPPRESS 0 %	I/Q AMPL. BALANCE 0 %	I/Q MODE	CONSTITUTION	NOISE C/N
NOISE BANDWIDTH	7.5 MHz	REGULAR TUSD	DISABLED CARRIERS	F2=EXIT	

Status menu

ISDB-T: coding and mapping for antenna

The ISDB-T (terrestrial integrated services digital broadcasting) coder of the R&S®SFQ encodes an MPEG-2 data stream in line with standards for transmission in the RF channel. The transport stream first passes through the outer coder where each transport stream packet undergoes Reed-Solomon encoding. The receiver is thus able to correct up to eight errored bytes in one transport stream packet.

The error-protected data stream then passes through a splitter which divides the transport stream packets between as many as all three hierarchical layers. The subsequent energy dispersal module adds a pseudo random binary sequence (PRBS) to the data stream to ensure a sufficient number of binary changes.

Depending on the two transmission parameters "modulation" and "code rate", a varying delay of the data stream in the three paths is obtained through bitwise interleaving in the transmitter and de-interleaving in the receiver. Delay adjustment is performed in the coder to minimize the technical effort at the receiver end. In this module, the three data streams are delayed so that subsequent delay differences can be compensated for beforehand.

Bitwise interleaving separates initially adjacent bytes and thus makes the signal resistant to burst errors.

The convolutional coder with integrated puncturer adds further redundancy to the data stream to permit error correction in the receiver (Viterbi decoder). The code rate can be selected according to the

required transmission characteristics of the system.

Modulation comes next. It includes bit-wise interleaving with delay adjustment and mapping to the modulation constellation diagram. Possible ISDB-T constellations are DQPSK, QPSK, 16QAM and 64QAM. The constellation can be selected according to the required transmission characteristics of the system. Appropriate bitwise interleaving and delay adjustment are automatically selected.

The hierarchical data stream is then synthesized. For this purpose, the complex mapped data from each of the three paths is added to form a serial data stream.

Synthesis is followed by symbol-by-symbol time interleaving which is performed by an intra-segment time interleaver

RF FREQUENCY	RF LEVEL	MODULATION	SYMBOL RATE	C/N	FADING
210.250 MHz	67.0 dBµV	ATSC 8VSB	10.762 MSym/s	OFF	OFF
DUB-S QPSK	DUB-C QAM	DUB-T COFDM	ATSC USB	IO EXTERNAL	PRESETPR
ATSC 8VSB MODULATION I/Q PHASE ERROR 0 DEG CARRIER SUPPRESS. 0 % I/Q AMPL. BALANCE 0 % I/Q MODE NORMAL VSB LEVEL 8VSB NOISE C/N 25.0 dB NOISE BANDWIDTH 5.4 MHz FADING: USER REGULAR TU50		CODER INPUT ASI DATA RATE 19.393 MBit/s MODE DATA ROLL OFF 0.115 RANDOMIZER ON REED SOLOMON ON INTERLEAVER ON PILOT ON PILOT VALUE 1.25			
F2=EXIT					

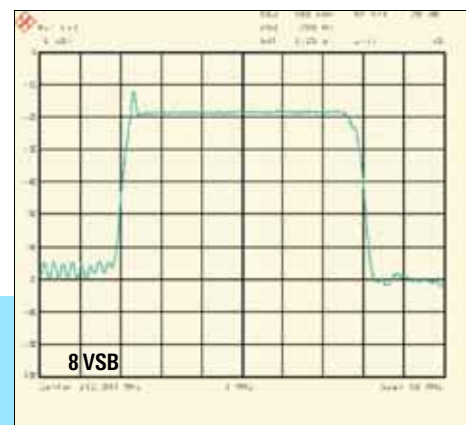

Status menus

RF FREQUENCY	RF LEVEL	MODULATION	USED BANDWIDTH	C/N	FADING
485.142857 MHz	-30.0 dBm	ISDB-T MODE1	5.575 MHz	OFF	OFF
RF FREQUENCY	RF LEVEL	MODULATION	I/Q CODER	ROLL OFF	SPECIAL
I/Q CODER INPUT SELECT → SPI USEFUL DATA RATE MAX → 21.298475 MBit/s USEFUL DATA RATE MEASURE → 0.000 MBit/s MODE → DATA CODE RATE → 7/8 TIME INTERLEAVING → 8 ISDB-T MODE → MODE1 (2K) GUARD INTERVAL → 1/8 BANDWIDTH → 5.575397 MHz SPECIAL →		LAYER A / 13 SEG(S) INPUT DATA RATE: 10.000 MBit/s 0.000000 MBit/s 0.000000 MBit/s PRBS TS PACKET 7/8 7/8 8		LAYER B / 0 SEG(S) LAYER C / 0 SEG(S) 0.000000 MBit/s 0.000000 MBit/s 0.000000 MBit/s PRBS TS PACKET 7/8 7/8 8	
F2=STATUS F4=PRESET CODER					

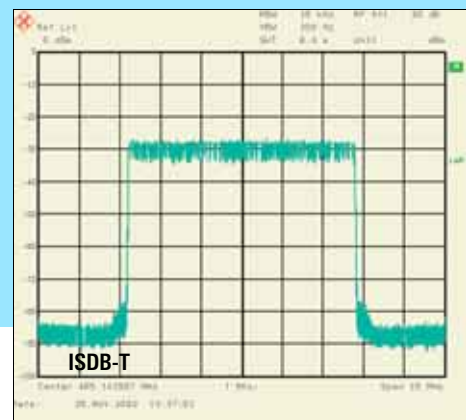

whose depth can be selected specifically for each layer. Delay adjustment is also assigned to the time interleaver in order to compensate for different delays in the paths.

Subsequent frequency interleaving scrambles the data in an OFDM symbol, i.e. in the frequency domain. First an inter-segment interleaver is applied between the OFDM segments that have the same modulation, followed by an intra-segment interleaver that rotates the data in a segment. Finally, the data passes through an intra-segment randomizer that shifts the data in a segment to quasi-random positions.

The next step is OFDM framing. Frames are formed from 204 OFDM symbols by adding pilot carriers. Depending on the mode and the selected modulation, pilot carriers are inserted into the data stream at different positions. Moreover, TMCC (transmission and multiplexing configuration control) carriers and AC (auxiliary channel) carriers are added.

The data generated in this way undergoes inverse fast Fourier transform (IFFT) to transfer it from the frequency domain

to the time domain as is usual with OFDM modulation. The length of IFFT depends on the selected ISDB-T mode and can be 2K, 4K or 8K.

IFFT is followed by the insertion of the guard interval. This guard interval extends the OFDM symbols by a specific factor (1/4, 1/8, 1/16 or 1/32). This measure has a positive effect on the receiving characteristics in the case of multipath propagation and mobile reception.

ITU T J.83-B: coding and mapping for cable

The symbol rate of the coder and consequently the bandwidth of the output signal can be varied over a wide range of $\pm 10\%$ of the standard symbol rate.

Larger variations of the symbol rate can be made in the TS parallel mode, where the symbol rate of the coder immediately follows the coder input data rate. However, conformance with specifications cannot be warranted outside the range $\pm 10\%$.

The data signal applied to the R&S®SFQ can be replaced with an internal test sequence (NULL TS PACKETS, NULL PRBS PACKETS, SYNC PRBS), which is helpful for BER measurements.

In the J.83-B cable transmission system, additional error control is introduced at the transport stream level by means of a sliding checksum, calculated for the transport stream packets, and substituted for the sync byte. This checksum byte allows the receiver to synchronize to the packets and to check for errored packets.

The J.83-B FEC layer, which is next, accepts and transports data without any restrictions imposed by the protocol, i.e. checksum generation and FEC coding are completely independent processes.

FEC in the J.83-B system is implemented in the four following stages to ensure reliable data transmission via cable:

- ◆ Reed-Solomon coding (128, 122) for outer error correction, allowing up to three symbols in a Reed-Solomon block to be corrected
- ◆ A convolutional interleaver distributing consecutive symbols uniformly across the data stream, thus protecting the signal from burst-type impairments
- ◆ A randomizer to give a uniform power density in the channel
- ◆ Trellis coding for inner error correction, involving convolutional coding of data and adding defined redundant information to the symbols, thus enabling the receiver to detect and correct any sporadic impairments on the transmission path by means of soft-decision methods

The randomizer, interleaver and Reed-Solomon coder can be switched off, which is very useful when receivers are being developed.

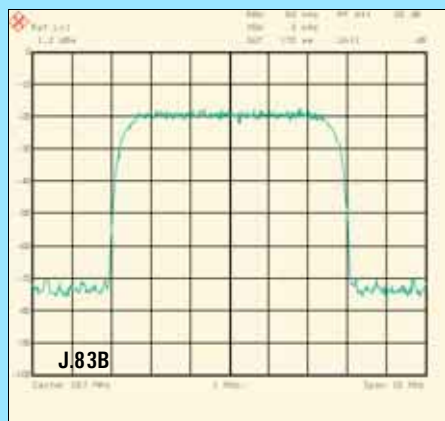

Coding: The coder expects an MPEG-coded input data stream packetized to standard with a packet length of 188 bytes. The data is divided into packets by means of a sync byte (47 hex) in the transport stream, the sync byte also being used for receiver synchronization.

All interleaver modes defined in J.83-B are implemented (level 1 and level 2), allowing the system to adapt easily to different transmission conditions.

FEC frame: With 64QAM, a frame sync trailer is inserted after 60 Reed-Solomon packets (with 256QAM after 88 Reed-Solomon packets), thus forming an FEC frame. The frame sync trailer is a sync word that carries information about the current interleaver configuration. The trailer is inserted immediately ahead of trellis coding and used by the receiver for FEC synchronization and interleaver mode evaluation.

The trellis coder for 64QAM performs differential coding of the input data as well as 4/5 punctured convolutional coding. The overall code rate is 14/15, i.e. the trellis coder generates 15 output bits from 14 input bits. The output word length of the trellis coder is 6 bits, corresponding to the modulation level of 6 for 64QAM. The output signal of the trellis coder is applied to the mapper, which converts the symbols formed by the trellis coder into constellation points. The trailer is also coded by the trellis coder like normal FEC data and, because of its length, occupies all the bit positions in a trellis group.

The differential/convolutional encoder in the trellis block for 256QAM is identical to the 64QAM trellis coder but has an overall code rate of 19/20. In contrast to 64QAM, the trailer is inserted only at the differentially coded bit positions of a trellis group and transmitted in five sync trellis groups because of its length. The output word length is 8 bits, corresponding to 256 constellation points.

After the mapper and prior to modulation, the output spectrum is band-limited by a $\sqrt{\cos}$ roll-off filter to match the 6 MHz channel spacing. Roll-off is 0.18 with 64QAM and 0.12 with 256QAM in line with the standard.

Input interface

The optional input interface adds two further inputs to the base units TS PARALLEL input in LVDS (low voltage differential signalling) format: SPI (synchronous parallel interface) and ASI (asynchronous serial interface). An SMPTE310M input is moreover available in the case of ATSC/8VSB and J.83-B.

SPI and ASI inputs allow setting of the symbol rate independently of the input data rate, so that the input data rate is independent of the symbol rate or channel bandwidth. To this effect, all null packets are removed. The data rate required for a given symbol rate or bandwidth is obtained by stuffing, i.e. by inserting new null packets. The PCR (program clock reference) values are adapted. A built-in synthesizer ensures an accurate data clock at all inputs. For synchronization to a receiver, an external clock can be applied to ASI and SPI instead of the internal clock.

Fading simulation

For receiver testing, it is necessary to simulate all real-life transmission conditions as completely as possible and in a reproducible way. The R&S® SFQ caters for this necessity by offering a fading simulator in addition to the noise generator. The fading simulator is indispensable for the simulation of terrestrial – and in particular mobile – receive conditions, but can also be used for QAM and QPSK (max. 14 MHz RF bandwidth), for example to simulate reflection. For fading simulation, a signal is passed through 6 or 12 parallel paths which are combined again ahead of the modulator. Each active simulation path shapes the signal independently of the other paths and without any synchronization between the paths.

For each path, loss and delay can be set individually and a profile selected. Various profiles are available. The constant phase profile allows extremely short delays to be simulated.

RF FREQUENCY	RF LEVEL	MODULATION	SYMBOLRATE	C/N	FADING
1750.000 MHz	-30.0 dBm	DVB-S 8PSK	45.000 MSym/s	OFF	OFF
RF FREQUENCY	RF LEVEL	MODULATION	I/Q CODER	BASERAND	SPECIAL
I/Q CODER		EDIT (INFO)		MEASURE	
INPUT SELECT →	ASI			19.393 Mbit/s	
INPUT DATA RATE	(MAX. 103.676 Mbit/s)			4.556 Mbit/s	
USEFUL DATA RATE	45.000 MSym/s				
SYMBOL RATE →	DATA				
MODE →	5/6				
CODE RATE →	0.35				
ROLL OFF →					
SPECIAL →					
			F2=STATUS	F4=PRESET CODER	

Typical operating menu

SETUP						
HARDWARE	INFO	TIME/DATE	COMMUNICAT	PRESET	CHANNEL TABLE	FADING PARAMETER
REGULAR TUSO	PATH 1	PATH 2	PATH 3	PATH 4	PATH 5	PATH 6
PATH STATE	ON	ON	ON	ON	ON	ON
PROFILE	RAYLEIGH	RAYLEIGH	RAYLEIGH	RAYLEIGH	RAYLEIGH	RAYLEIGH
PATH LOSS	3.0 dB	0.0 dB	2.0 dB	6.0 dB	8.0 dB	10.0 dB
DELAY	0.50 μs	0.20 μs	0.50 μs	1.60 μs	2.30 μs	5.00 μs
SPEED	13.9 m/s	13.9 m/s	13.9 m/s	13.9 m/s	13.9 m/s	13.9 m/s
DOPPLER FREQUENCY	22.0 Hz	22.0 Hz	22.0 Hz	22.0 Hz	22.0 Hz	22.0 Hz
PHASE	OFF	OFF	OFF	OFF	OFF	OFF
DISCREET COMPONENT	OFF	OFF	OFF	OFF	OFF	OFF
POWER RATIO	10.0%	10.0%	10.0%	10.0%	10.0%	10.0%
FREQUENCY RATIO	1.0	1.0	1.0	1.0	1.0	1.0
ACTIVE SET: REGULAR TUSO		/ OFF		F2=ALL EQUAL		F4=PG DOWN

Setup menu for fading: regular TU50 (i.e. typical urban, 50 km/h, 6 paths)

The pure Doppler profile is suitable for the simulation of mobile reception. Mobile reception means that the receiver is moving or the signal is reflected by a moving object. The assumed speed of movement can be varied over a wide range. Moreover, the direction of movement can be defined with reference to the transmitter site. Special profiles have been developed for the reproducible simulation of complex scenarios. The profiles are based on the WSSUS (wide sense stationary uncorrelated scattering) model and are recommended by the relevant DVB and DAB bodies (MOTIVATE, COST 207, EUREKA 147). Rayleigh fading, for example, simulates a radio field with many strongly scattered partial waves uniformly distributed and arriving at the mobile receiver from all directions. Rice fading simulates the same situation as Rayleigh fading, but with a variable, discrete component received via a direct path. Lognormal fading simulates slow variation of the receive amplitude; together with Rayleigh fading, Suzuki fading is obtained.

To configure a complete channel simulation model, a large number of parameters has to be set for each of the 6 or 12 paths: on/off, profile, loss, delay, speed/Doppler frequency, direction, discrete component, local constant for lognormal. To provide for comparable, reproducible measurements, international bodies recommend the use of defined channel models, for example typical urban, rural area, hilly terrain, difficult RA250 (difficult rural area, 250 km/h). The fading simulator offers the recommended as well as frequently used channel models as pre-defined setups for convenient testing. All parameters can be modified to match the requirements of a given task.

Following the fading simulator, all paths are combined for modulation. Simulation may cause a considerable change of RF power. Depending on the settings of the FADING POWER parameter (MULTIPATH or MAIN), the R&S® SFQ displays the total power of all paths involved or the power of the main path. The C/N ratio is set according to the two power models.

With different phases in the individual paths, RF power may be reduced through cancellation and, more frequently, increased through addition of the paths. Therefore, with the fading simulator switched on, the maximum RF level is reduced to avoid overloading.

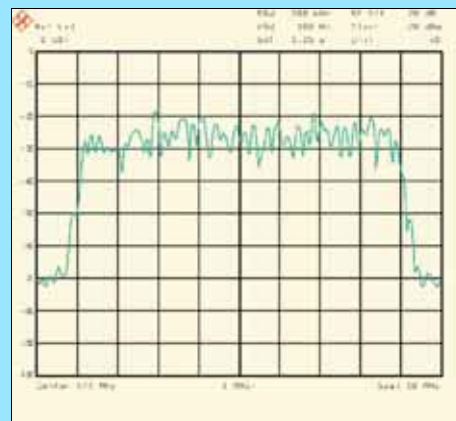
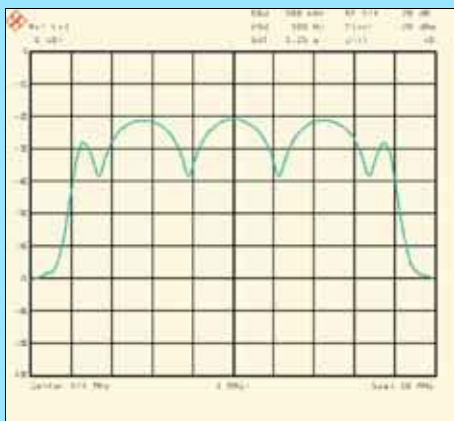

DVB-T spectrum with constant phase (phase 0 degree, delay 0 μ s/0.45 μ s, 2 paths) and regular TU50 fading (typical urban, 50 km/h, 6 paths)

Noise generator

The noise generator produces broadband white noise with a Gaussian distribution. The power density of the noise signal can be set indirectly as C/N (carrier-to-noise) ratio.

This is extremely convenient for the user as the C/N ratio can be entered in dB immediately after selection of the demodulator receive bandwidth. The receive bandwidth is set to match the symbol rate but can be modified. The R&S®SFQ can thus simulate different types of interference as they really occur along the satellite, cable or antenna transmission path to the receiver. The C/N ratio is set according to the two fading power models (FADING POWER). Featur-

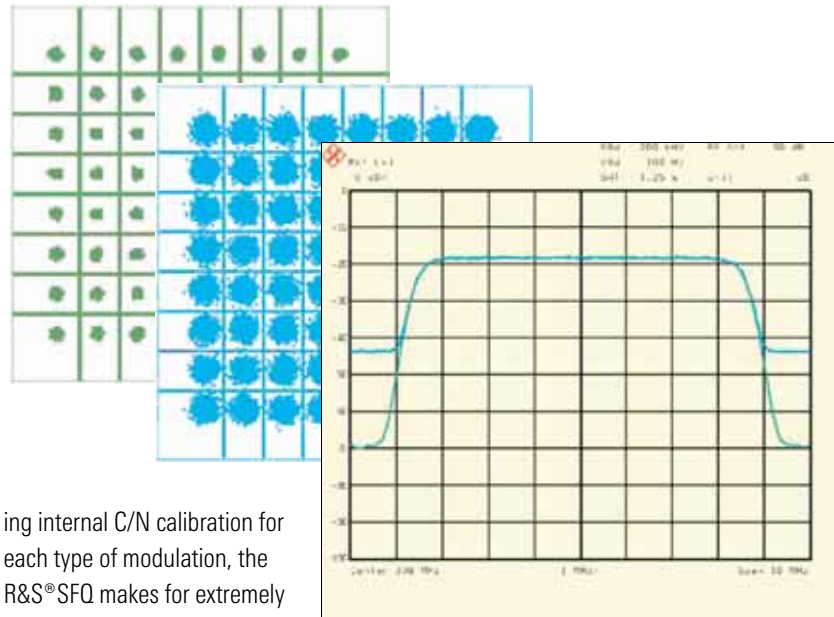

ing internal C/N calibration for each type of modulation, the R&S®SFQ makes for extremely high accuracy.

DVB-C spectrum without and with noise (24 dB C/N), associated I/Q constellations

Circuit diagram with two R&S®SFQs and R&S®SFQ-Z5 cable set for generating diversity signals

- RF frequency above 10 MHz doubled
- Same fading profile, but uncorrelated
- Uncorrelated noise generators for every receive path
- Cascadable for several diversity signals

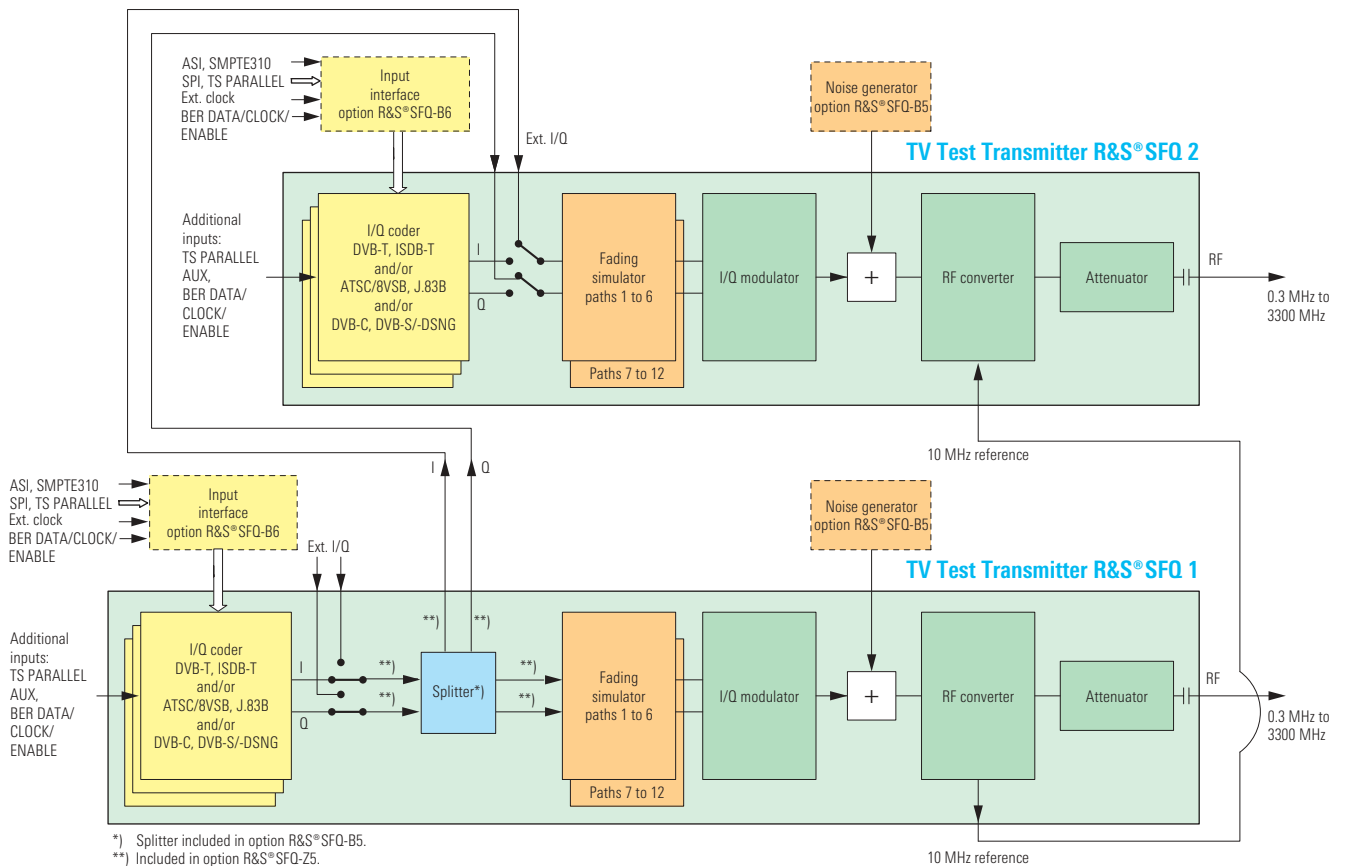

Impulsive noise

Together with the Noise Generator R&S®SFQ-B5 (from model 04), the option Impulsive Noise R&S®SFQ-B27 is also available for the TV Test Transmitter R&S®SFQ. It enables users not only to set an accurate C/N ratio that can be calibrated but also to superimpose impulsive noise.

Diversity simulation

For testing diversity receivers, each antenna of the receiver requires a separate RF signal. The RF signals must carry the same MPEG signal and be coupled to each other via the reference frequency. The interference simulation (noise, fading) produced by the individual transmitters must not be intercorrelated; this can be realized only by providing one R&S®SFQ per antenna. Only one MPEG-2 transport stream is used; the RF is coupled to the reference frequency (see block diagram opposite). To enable cascading, which is required for this application, the noise generator incorporates a splitter which can be activated by means of the accessory Cable Set R&S®SFQ-Z5.

BER measurement

The internal BER measurement facility permits the BER of receivers to be measured without external equipment being required. The demodulated data streams are fed back to the R&S®SFQ.

A selection can be made between the serial inputs DATA, CLOCK (BNC connectors, TTL level, 75 Ω) and the parallel input for MPEG signals (sub-D, LVDS level). The BER measurement is independent in its function from other settings in the R&S®SFQ and can be used with all digital modulation modes. The current BER is permanently displayed for this purpose.

A PRBS of $2^{23}-1$ or $2^{15}-1$ to ITU-T Rec. O.151 can be selected and evaluated. It ensures receiver synchronization and allows measurements over a very wide BER range.

A serial BER measurement can be performed after the demapper, for instance. For parallel measurements on MPEG-2 transmission systems, the R&S®SFQ is set to NULL PRBS PACKET. The BER measurement can thus be carried out before the Reed-Solomon decoder, for instance. The BER of set-top boxes can be determined with the aid of an adapter board for the Common Interface R&S®SFQ-Z17.

The BER measurement facility is located on the INPUT INTERFACE (model >.02) or on the DVB-T coder module, which means that the R&S®SFQ must be equipped with at least one of these modules.

I/Q modulation

In the I/Q modulator, the orthogonal I and Q components of the RF signal are controlled in amplitude and phase by the analog I and Q signals from the coder. The two RF components are added to give an output signal that can be amplitude- and phase-modulated as required. Assignment of I and Q components can be interchanged in the R&S®SFQ so that an inverted RF signal is obtained. High demands are placed on the I/Q modulator particularly with a view to high-order quadrature amplitude modulation. The internal calibration of the R&S®SFQ ensures that I and Q paths have identical gain, the phase is exactly 90° and carrier suppression at least 50 dB. Non-ideal behaviour of an I/Q modulator can be simulated by detuning amplitude, phase and carrier leakage in the R&S®SFQ. As a result, bit errors are produced that allow quality assessment of receivers and demodulators.

RF FREQUENCY	RF LEVEL	MODULATION	USED BANDWIDTH	C/N	FADING
474.000 MHz	-30.0 dBm	DVB-T 64QAM	7.607 MHz	OFF	OFF
BER: 8.52E-07	(2610 / 10K)				
RF FREQUENCY	RF LEVEL	MODULATION	I/Q CODER	FADING	SPECIAL
SPECIAL		BER INPUT	PARALLEL		
SWEEP START/STOP →					
SWEEP CENTER/SPAN →					
BER MEASUREMENT		ON			
BER		8.52E-07 (2610 / 10K)			
▶ BER INPUT		PARALLEL	▶ MODE		
					PRBS PRBS INVERTED ▶ NULL PRBS PACKET PID F. FOR PRBS PACKET
F2=STATUS					

BER setting menu

Specifications

Base unit

Frequency (main carrier)	
Range	0.3 MHz to 3.3 GHz
Resolution	1 Hz
Accuracy	see reference frequency

Reference frequency	
Inaccuracy	$<\pm 1 \cdot 10^{-6}$
Aging (after 30 days of operation)	$1 \cdot 10^{-6}$ /year
Temperature effect (0°C to 55°C)	$2 \cdot 10^{-6}$
Output for internal ref. frequency	10 MHz
Level (V_{rms} EMF, sinewave)	1 V
Input for external reference	
Frequency	5 MHz or 10 MHz
Permissible frequency drift	$3 \cdot 10^{-6}$
Input level (V_{rms})	0.1 V to 2 V
Input impedance	200 Ω

Spectral purity	
Spurious signals	
Harmonics (up to 5 GHz)	<-30 dBc
Nonharmonics	
CW	<-70 dBc
I/Q modulation	<-56 dBc (ref. to CW)
SSB phase noise	measured at 750 MHz, CW, 1 Hz bandwidth
Offset from carrier	
1.1 kHz	-85 dB
2.2 kHz	-89 dB
3.4 kHz	-94 dB
4.5 kHz	-98 dB
8.9 kHz	-104 dB
13.4 kHz	-103 dB
20 kHz	<-108 dB
Spurious FM rms ($f = 1$ GHz), 0.3 kHz to 3 kHz (ITU-T)	<8 Hz

Level	
Range	
CW	-99.9 dBm to $+13$ dBm
DVB-T	-99.9 dBm to $+6$ dBm
ATSC/8VSB	-99.9 dBm to $+3$ dBm
ISDB-T	-99.9 dBm to $+4$ dBm
DVB-C/DVB-S	-99.9 dBm to $+7$ dBm
J.83-B	-99.9 dBm to $+2$ dBm
With fading	see R&S®SFQ-B11
Resolution	0.1 dB
Total level inaccuracy	$<\pm 1.5$ dB
Frequency response at 0 dBm	<1 dB, typ. <0.5 dB
Output impedance	50 Ω
VSWR	
RF level 13 dBm to 0 dBm	<2
<0 dBm to -99 dBm	<1.4
RF output	with DC block (max. 50 V DC)
Non-interrupting level setting	15 dB in selectable level range
Overtoltage protection	protection against externally fed RF power

External I/Q input	
(for optional I/Q output/input see page 16)	
Modulation inputs for external feed of I and Q	
Input impedance	50 Ω
VSWR (DC to 30 MHz)	<1.4
Input voltage for full-scale level	$(I^2 + Q^2)^{1/2} = 0.5$ V (1 V EMF, 50 Ω)
Level correction for nominal	
RF output level	0 dB to 40 dB
Connector	BNC female

I/Q modulation ¹⁾	
Modulation frequency response	
DC to 3.5 MHz	
RF = 0.3 MHz to 1000 MHz	$<\pm 0.2$ dB
RF = 0.3 MHz to 3300 MHz	$<\pm 0.3$ dB

DC to 17.5 MHz, RF = 0.3 MHz to 3300 MHz	$<\pm 0.8$ dB
DC to 22.5 MHz RF = 0.3 MHz to 3300 MHz	$<\pm 1$ dB
Carrier leakage at 0 V input voltage referred to full-scale level with fading	<-50 dBc (after I/Q calibration in setup menu) see option R&S®SFQ-B11
Carrier leakage	
Setting range	0% to 50%
Resolution	0.1%
I/Q amplitude imbalance	
Setting range	-25% to $+25\%$
Resolution	0.1%
Quadrature offset (phase error)	
Setting range	-10° to $+10^\circ$
Resolution	0.1°

Data input for MPEG-2 data stream	
TS PARALLEL input	synchronous parallel (without stuffing), LVDS
Characteristics	meet EN50083-9
Input impedance	100 Ω
Input level (V_{pp})	100 mV to 2 V
Connector	25-contact female, shielded
Symbol rate (DVB-C, DVB-S)	
Accuracy	
with external MPEG signal	synchronized to external MPEG signal
without external MPEG signal	see optional input interface (R&S®SFQ-B6)
ASI (asynchronous serial input, with stuffing)	see optional input interface
SPI (synchronous parallel input, with stuffing)	see optional input interface
SMPT E (synchronous input)	see optional serial input interface

¹⁾ Valid for a warm-up period of 1 hour, recalibration for an operating time of 4 hours and temperature variations less than 5 degrees.

DVB/8VSB/ISDB-T/J.83-B

Input Interface	option R&S®SFQ-B6
SPI input	synchronous parallel (with stuffing), LVDS
Characteristics	meet EN50083-9
Input impedance	100 Ω
Input level (V_{pp})	100 mV to 2 V
Connector	25-contact female, shielded
ASI input	asynchronous serial, with stuffing
Characteristics	meet EN50083-9
Input impedance	75 Ω
Input level (V_{pp})	200 mV to 880 mV
Connector	BNC female
Input signal	270 Mbit
Stuffing bytes	single-byte and block mode
Input SMPTE 310	synchronous serial (only in conjunction with ATSC/8VSB coder)
Characteristics	meet SMPTE310M
Input impedance	75 Ω
Input voltage (V_{pp})	400 mV to 880 mV
Connector	BNC female
Data rate	19.392658 Mbit/s
Symbol rate (SPI, ASI)	selectable by inserting null PRBS packets (stuffing)
Inaccuracy of internal data clock	$<\pm 1 \cdot 10^{-5}$
External clock	switchable between bit and byte clock
Signal, level	TTL
Input impedance	high-impedance
Connector	BNC female
Internal transport stream	null transport stream packets with PRBS as payload (PRBS: $2^{23}-1/2^{15}-1$ to ITU-T Rec. O.151)

DVB-T Coder	option R&S®SFQ-B10
Characteristics	meet EN300744
Input	TS PARALLEL; with R&S®SFQ-B6: ASI, SPI
Mode	
DATA	MPEG input signal synchronized to input data rate
NULL TS PACKET	null transport stream packets as defined by Measurement Guidelines for DVB Systems
NULL PRBS PACKET	null transport stream packets with PRBS (PRBS: $2^{23}-1/2^{15}-1$ to ITU-T Rec. 0.151)
PRBS before convolutional encoder	$2^{23}-1/2^{15}-1$ to ITU-T Rec. 0.151
PRBS after convolutional encoder	$2^{23}-1/2^{15}-1$ to ITU-T Rec. 0.151
PRBS before mapper	$2^{23}-1/2^{15}-1$ to ITU-T Rec. 0.151
Special functions	scrambler, sync byte inversion, Reed-Solomon, convolutional interleaver, bit interleaver, symbol interleaver, can be switched off
Bandwidth	6 MHz, 7 MHz, 8 MHz (selectable for variable bandwidth from: 5.164 MHz to 7.962 MHz)
Constellation	QPSK, 16QAM, 64QAM
Code rate	$1/2, 2/3, 3/4, 5/6, 7/8$
Guard interval	$1/4, 1/8, 1/16, 1/32$, OFF
FFT mode	2K and 8K COFDM
Carrier modification	switching off carriers, carrier groups, modulation for carrier groups
Hierarchical coding	can be retrofitted (see opt. R&S®SFQ-B16)

DVB-T/Hierarchical Coding	option R&S®SFQ-B16
only in conjunction with option R&S®SFQ-B10	
Characteristics	meet EN300744
AUX input	TS PARALLEL or SPI (parallel, with stuffing); selectable
Assignment	to high-priority or low-priority path
Mode	for high-priority and low-priority path
DATA	MPEG input signal
NULL TS PACKET	null transport stream packets as defined by Measurement Guidelines for DVB Systems
NULL PRBS PACKET	null transport stream packets (PRBS: $2^{23}-1/2^{15}-1$ to ITU-T Rec. 0.151)
PRBS before convolutional encoder	$2^{23}-1/2^{15}-1$ to ITU-T Rec. 0.151
PRBS after convolutional encoder	$2^{23}-1/2^{15}-1$ to ITU-T Rec. 0.151
PRBS before mapper	$2^{23}-1/2^{15}-1$ to ITU-T Rec. 0.151
Special functions	scrambler, sync byte inversion, Reed-Solomon, convolutional interleaver, bit interleaver, symbol interleaver; can be switched off

ATSC/8VSB Coder	option R&S®SFQ-B12 (-B8)
Characteristics	meet ATSC Doc. A/53 (8VSB)
Frequency setting	pilot frequency, center frequency, channel tables
Input data rate	19.392658 Mbit/s
Range	±10% (larger range with option R&S®SFQ-B6)
Input	LVDS, with R&S®SFQ-B6: ASI, SPI, SMPTE310
Mode	
DATA	MPEG input signal with synchronization to input data rate
NULL TS PACKET	null transport stream packets as defined by Measurement Guidelines for DVB Systems
NULL PRBS PACKET	null transport stream packets (PRBS: $2^{23}-1/2^{15}-1$ to ITU-T Rec. 0.151)
SYNC PRBS	sync byte with 187 bytes PRBS payload
PRBS before trellis	$2^{23}-1/2^{15}-1$ to ITU-T Rec. 0.151
PRBS after trellis	$2^{23}-1/2^{15}-1$ to ITU-T Rec. 0.151
Symbol rate	10.762 Msps
Range	±10%
Bandwidth	6 MHz
Range	±10%

VSB level	8VSB
Pilot	1.25, can be switched off
Range	0 to 5 in steps of 0.125
Pulse filtering (root cosine)	0.115 roll-off
Special functions	randomizer, interleaver; can be switched off
Error simulation	selectable: carrier leakage, I/Q imbalance, I/Q phase error

ISDB-T Coder	option R&S®SFQ-B26
Characteristics	meet ARIB STD-B31, V1.0
Inputs	TS PARALLEL + AUX and SPI with R&S®SFQ-B6: ASI
Mode	
DATA	PRBS: $2^{23}-1/2^{15}-1$ to ITU-T Rec. 0.151
NULL TS PACKET	PRBS: $2^{23}-1/2^{15}-1$ to ITU-T Rec. 0.151
PRBS TS PACKET	PRBS: $2^{23}-1/2^{15}-1$ to ITU-T Rec. 0.151
PRBS before convolutional encoder	PRBS: $2^{23}-1/2^{15}-1$ to ITU-T Rec. 0.151
PRBS after convolutional encoder	PRBS: $2^{23}-1/2^{15}-1$ to ITU-T Rec. 0.151
Special functions	scrambler, Reed-Solomon, byte interleaver, frequency interleaver, Alert Broadcasting Flag can be switched off
Bandwidth	6 MHz
Carriers	data, SP, CP, TMCC and AC carriers as well as the modulation of these carriers can be switched off
Segments	all carriers of one segment can be switched off
ISDB-T mode	mode 1 (2K), mode 2 (4K), mode 3 (8K)
Number of layers	max. 3 (A, B, C)
Number of segments	13
Constellation	DQPSK, QPSK, 16QAM, 64QAM
Code rate	$1/2, 2/3, 3/4, 5/6, 7/8$
Guard interval	$1/4, 1/8, 1/16, 1/32$, OFF
Time interleaving	0, 1, 2, 4, 8, 16 (settable depth depending on ISDB-T mode)
AC information	PRBS, all "1"
Spectrum mask	according to ISDB-T specifications

DVB-C Coder	option R&S®SFQ-B21 (-B22)
Characteristics	meet EN 300 429
Type of modulation	16QAM, 32QAM, 64QAM, 128QAM, 256QAM
Symbol rates	0.1 Msps to 8 Msps (selectable)
Pulse filtering	root cosine roll-off, alpha=0.15 variable roll-off (0.1 to 0.2)
Energy dispersal	can be switched off
Reed-Solomon coder (204,188, t=8)	can be switched off
Convolutional interleaver	can be switched off
Mode	
DATA	MPEG-2 input signal (without input signal automatic switchover to PRBS with TS PARALLEL, stuffing with ASI, SPI)
NULL TS PACKET	null packets (PID=1FFF, payload=0)
NULL PRBS PACKET	null packets (PID=1FFF, payload=PRBS: $2^{15}-1/2^{23}-1$ to ITU-T Rec. 0.151)
PRBS before mapper	$2^{15}-1/2^{23}-1$ to ITU-T Rec. 0.151

ITU-T J.83-B Coder	option R&S®SFQ-B13 (-B9)
Only in conjunction with option R&S®SFQ-B6	
Characteristics	meets ITU-T J.83-B
Input data rate (nominal, range corresponding to symbol rate)	26.970 Mbit/s for 64QAM, 38.8107 Mbit/s for 256QAM
Input	LVDS, ASI, SPI, SMPTE310
Mode	
DATA	input signal synchronized to input data rate
NULL TS PACKET	null transport stream packets
NULL PRBS PACKET	null transport stream packets with PRBS (PRBS: $2^{23}-1/2^{15}-1$ to ITU-T Rec. 0.151)
SYNC PRBS	sync byte with 187 byte PRBS payload
PRBS before trellis coding	PRBS: $2^{23}-1/2^{15}-1$ to ITU-T Rec. 0.151
PRBS after trellis coding	PRBS: $2^{23}-1/2^{15}-1$ to ITU-T Rec. 0.151

Symbol rate	5.0569 Msps for 64QAM, 5.360 Msps for 256QAM
Range	±10%
Bandwidth	6 MHz
Pulse filtering (root cosine)	0.18 (64QAM), 0.12 (256QAM) roll-off
Data interleaver	level 1 and level 2; can be switched off
Special functions	switchable: randomizer, Reed-Solomon coder
Error simulation	selectable: carrier suppression, I/Q imbalance, I/Q phase error

DVB-S/-DSNG Coder **option R&S®SFQ-B23 (-B24)**

Not in conjunction with option R&S®SFQ-B6 model .02, R&S®SFQ-B6 model .03 recommended

Characteristics	meet EN 300 421/EN 301 210
Type of modulation	QPSK, 8PSK, 16QAM
Code rate	QPSK: $\frac{1}{2}, \frac{2}{3}, \frac{3}{4}, \frac{5}{6}, \frac{7}{8}$ 8PSK: $\frac{2}{3}, \frac{5}{6}, \frac{8}{9}$ 16QAM: $\frac{3}{4}, \frac{7}{8}$
Symbol rates	0.1 Msps to 80 Msps (selectable)
Pulse filtering	root cosine roll-off, alpha=0.35 variable roll-off (0.25 to 0.45)
Energy dispersal	can be switched off
Reed-Solomon coder (204,188, t=8)	can be switched off
Convolutional interleaver	can be switched off
Convolutional encoder	can be switched off
Mode	
DATA	MPEG-2 input signal (without input signal automatic switchover to PRBS with TS PARALLEL, stuffing with ASI, SPI)
NULL TS PACKET	null packets (PID=1FFF, payload=0)
NULL PRBS PACKET	null packets (PID=1FFF, payload=PRBS, $2^{15}-1/2^{23}-1$ to ITU-T Rec. 0.151)
PRBS before convolutional encoder	$2^{15}-1/2^{23}-1$ to ITU-T Rec. 0.151

I/Q Output/Input **option R&S®SFQ-B14**

Output	
Output impedance	50 Ω
Output voltage	depending on selected modulation
Connector	BNC female
Input	
Input impedance	50 Ω
VSWR (DC to 30 MHz)	<1.4
Input voltage for full-scale level	$(I^2 + Q^2)^{1/2} = 0.5 \text{ V}$ (1 V EMF, 50 Ω)
Connector	BNC female

Transmission simulation

Fading Simulator	option R&S®SFQ-B11
Model .02	paths 1 to 6 (R&S®SFQ delivered before 1999; see R&S®SFQ-B18)
Model .04	paths 7 to 12 (only in conjunction with R&S®SFQ-B11, model .02)
Reduced maximum RF output level	-5.5 dBm for DVB-T (single-path fading without loss)
RF output power	MULTIPATH: the RF level displayed is the sum of the power levels in the individual paths MAIN: the RF level displayed is the power of the main path
C/N ratio	maintained if fading parameters are changed; MULTIPATH : C=total power of all paths MAIN: C=power of main path
RF bandwidth (-3 dB)	>14 MHz
Frequency response up to 5 MHz offset from carrier frequency	<0.6 dB, typ. <0.3 dB
Carrier leakage	typ. 42 dBc
Number of paths with R&S®SFQ-B11	
Model .02	6
Model .02 plus model .04	12

Path loss	
Range	0 dB to 50 dB
Resolution	0.1 dB
Inaccuracy (from 0 dB to 20 dB)	<0.3 dB
Path delay	
Range	0 μs to 1600 μs
Resolution	50 ns
Inaccuracy	<5 ns
Constant phase	
Range	0° to +359.9°
Resolution	0.1°
Pure Doppler	
Frequency range	0.1 Hz to 1600 Hz
Speed range	$v_{\min} = (0.03 \cdot 10^8 \text{ m/s}^2)/f_{\text{RF}}$ $v_{\max} = (479 \cdot 10^9 \text{ m/s}^2)/f_{\text{RF}}$ for $f_{\text{RF}} = 1 \text{ GHz}$ $v_{\min} = 0.1 \text{ km/h}$, $v_{\max} = 1724 \text{ km/h}$
Resolution	0.1 km/h, m/s, mph
Inaccuracy	<0.13%
Rayleigh fading	
Pseudo noise interval	>372 h
Deviation from theoretical CPDF ¹⁾ at $P_{\text{avg}} = 0 \text{ dB}$	
From -20 dB to +10 dB	<1 dB, typ. <0.3 dB
From -30 dB to -20 dB	<2 dB, typ. <0.3 dB
Rice fading	
Power ratio ²⁾	
Range	-30 dB to +30 dB
Resolution	0.1 dB
Frequency ratio	
Range	-1 to +1
Resolution	0.05
Lognormal fading, Suzuki fading	
Standard deviation	
Range	0 dB to 12 dB
Resolution	1 dB
Local constant	I_{\min} : up to 200 m $(I_{\min} = (12 \cdot 10^9 \text{ m/s}^2)/f_{\text{RF}})$
Fading profile	
selectable from a list of predefined profiles; each profile can be modified as required	
Reference on frequency change	
speed or Doppler frequency can be selected	

Noise Generator **option R&S®SFQ-B5**

Not in conjunction with R&S®SFQ-B2 (is already included)

Bandwidth	
Receiver bandwidth	0.1 MHz to 80 MHz (selectable)
Actual noise bandwidth	10 MHz/60 MHz
C/N setting	
Variation range	50 dB
Minimum selectable C/N	depending on bandwidth and modulation (see diagram)
Resolution	0.1 dB
C/N error	
Absolute error	<0.3 dB (after calibration), typ. <0.2 dB
RF frequency range	
With noise bandwidth ≤10 MHz	≥15 MHz
With noise bandwidth >10 MHz	≥60 MHz

Minimum selectable C/N ratio of Noise Generator R&S®SFQ-B5

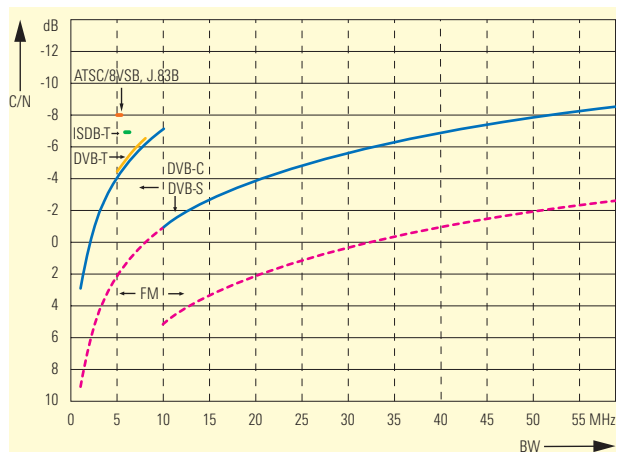

Impulsive Noise	option R&S®SFQ-B27
Option R&S®SFQ-B27 only together with option R&S®SFQ-B5 (from model 04)	
Pulse input	BNC, 75 Ω, TTL
Pulse	
Width	min. 200 ns
Frequency	≤2.5 MHz
Low Level	C/N standard
High Level	switchover to IMPULSIVE C/N value
Difference, IMPULSIVE C/N relative to C/N	in 1 dB steps
Variation range	corresponds to C/N range of the option R&S®SFQ-B5

BER Measurement	option R&S®SFQ-B17
Only in conjunction with option R&S®SFQ-B10 or option R&S®SFQ-B6 model .03	
Characteristics	integrated BER measurement for all digital modulation modes (DVB-C, DVB-S, DVB-T, 8VSB, J.83-B, ISDB-T)
Input data rate	max. 60 Mbit/s (serial input)
PRBS	$2^{23}-1/2^{15}-1$ to ITU-T Rec. 0.151
Input	
Serial	BER DATA, BER CLOCK, BER ENABLE
Input impedance	75 Ω
Input level	TTL
Connector	BNC female
Clock, data	normal, inverted
Enable	always, active high, active low
BER mode	
PRBS	$2^{23}-1/2^{15}-1$ to ITU-T Rec. 0.151
Parallel	TS PARALLEL AUX
Characteristics	meet EN 50083-9
Input impedance	100 Ω
Input level	100 mV to 2 V, LVDS
Connector	25-contact female, shielded
BER mode	
PRBS, PRBS INVERTED	$2^{23}-1/2^{15}-1$ to ITU-T Rec. 0.151
NULL PRBS PACKET	evaluation of standard transport stream; total payload corresponding to PRBS (e.g. NULL PRBS PACKET of R&S®SFQ)
PID FILTER FOR PRBS PACKET	evaluation of null packets (PID=1FFF) of standard TS with payload corresponding to PRBS (e.g. stuffing with R&S®SFQ in ASI/SPI mode)

¹) CPDF = cumulative probability distribution function, level values referred to average output level value.

²) Ratio of discrete component to distributed component.

BB-FM

Broadband FM Modulator	option R&S®SFQ-B2
Analog modulation	broadband FM for video and FM/ADR sound subcarrier
Video transmission characteristics	
Type of modulation	frequency modulation (F3)
Standard	PAL, SECAM, NTSC; selectable
Nominal input level (V_{pp})	1 V (75 Ω)
Video frequency deviation	
Setting range	10 MHz to 40 MHz
Resolution	0.1 MHz
Hum suppression with level clamping on	>40 dB
Linear distortion	
Frequency response, 0 MHz to 5 MHz (ref. to 1.5 MHz and 25 MHz (pp) deviation, with preemphasis and lowpass filter)	<±0.5 dB
Group delay, 0 MHz to 4.8 MHz	<±20 ns with lowpass filter
Transients (streaking) with 200 ns rise and fall time	<±2%
Energy dispersal signal	
Signal type	25 Hz or 30 Hz triangular signal, coupled to frame frequency (625/525 lines)
Deviation, selectable	0 MHz to 4 MHz, automatically doubled when the video or baseband signal is switched off
Resolution	100 kHz

Nonlinear distortion	
Measurements	with standard video signal and preemphasis and deemphasis switched on
Differential gain at 25 MHz deviation	<1.5%
Differential phase at 25 MHz deviation	<1.5°
Video-frequency S/N ratio, ref. to 22.5 MHz deviation, with preemphasis and deemphasis 100 kHz to 5 MHz	>70 dB rms, weighted to ITU-R

Internal noise generator	
Bandwidth	
Receiver bandwidth	0.1 MHz to 80 MHz (selectable)
Actual noise bandwidth	10 MHz/60 MHz
C/N setting	
Variation range	50 dB
Minimum selectable C/N	depending on bandwidth and modulation (see diagram for R&S®SFQ-B5, FM)
Resolution	0.1 dB
C/N error	<1 dB
RF frequency range	
With noise bandwidth ≤10 MHz	≥15 MHz
With noise bandwidth >10 MHz	≥60 MHz

2 FM Sound Subcarriers	option R&S®SFQ-B3
Only in conjunction with option R&S®SFQ-B2 (included once in R&S®SFQ-B2)	
Number of subcarriers per module	2
Frequency range	5 MHz to 9 MHz
Resolution	10 kHz
Frequency deviation of IF carrier caused by FM sound subcarriers	
Setting range (RF deviation)	1 MHz (pp) to 4 MHz (pp)
Resolution	10 kHz
Audio signal input	
Frequency range	30 Hz to 15 kHz
Bandwidth without lowpass filter	100 kHz
Nominal input level	+9 dBm (600 Ω)
Input impedance	>5 kΩ, balanced
Connector	Lemo Triax
Internal modulation generator (DSP)	
Frequency range	30 Hz to 15 kHz
Resolution	100 Hz
Modulation distortion	<0.5%
Audio S/N ratio (ref. to 50 kHz deviation, AC-coupled)	>65 dB, weighted to CCIR
Preemphasis	50 μs, 75 μs, J.17, OFF; selectable

2 ADR Sound Subcarriers	option R&S®SFQ-B4
Only in conjunction with option R&S®SFQ-B2 (to ADR specifications)	
Number of subcarriers	2
Frequency range	0.1 MHz to 9 MHz
Resolution	10 kHz
Frequency deviation of IF carrier caused by ADR sound subcarriers	
Setting range (RF deviation)	1 MHz (pp) to 4 MHz (pp)
Resolution	10 kHz
Type of modulation	QPSK
Source data	internal, external, PRBS
Source data rate	192 kbit/s
Transmission rate	256 kbit/s
QPSK test	4 selectable test patterns; I/Q reversal
Bit error generator (symbol errors)	10^{-2} to 10^{-6}
External data input	only for one of the two subcarriers
Type	clock (invertible) and data
Level	RS-422
Data rate	192 kbit/s
Internal MUSICAM generator	two generators independent of each other (to ISO/IEC 11172-3 Layer II)
Mode	single, dual, stereo
Ancillary data (ANC)	1 of 4 internal data records can be selected, update from memory card
Audio generator	two for each MUSICAM channel
Frequency range	10 Hz to 20 kHz; 10 Hz steps
Amplitude range	100 dB; 0.1 dB steps
Preemphasis	50/15 μs, OFF

General data

Transmitter tables	5 with 100 entries each, editable or loadable by remote control
Storage of instrument settings	internally and on memory card
Interfaces	IEC 625/IEEE 488 bus, RS-232-C
Operating temperature range	+5°C to +45°C
Permissible temperature range	0°C to +50°C
Storage temperature range	-40°C to +70°C
Mechanical resistance	
Vibration, sinusoidal	5 Hz to 150 Hz, max. 2 g at 55 Hz, 55 Hz to 150 Hz, 0.5 g const., meets EN 60068-2-6, EN 61010-1, MIL-T-28800 D class 5
Vibration, random	10 Hz to 300 Hz, acceleration 1.2 g (rms)
Shock	40 g shock spectrum, meets MIL-STD-810 C and MIL-T-28800 D classes 3 and 5

Climatic resistance	95% rel. humidity, cyclic test at +25°C/+40°C, meets EN 60068-2-30
Electromagnetic compatibility	meets EMC directive of EU (89/336/EEC) and German EMC legislation
Power supply	90 V to 132 V/180 V to 265 V (autoranging), 47 Hz to 440 Hz (170 VA)
Electrical safety	meets EN 61010-1
Dimensions (W × H × D)	435 mm × 192 mm × 460 mm
Weight	approx. 20 kg, depending on options fitted



Rear view of the R&S® SFQ

Ordering information

Order designation

TV Test Transmitter (0.3 MHz to 3300 MHz) for		
DVB-T, 2K/8K	R&S®SFQ02+ R&S®SFQ-B10	2072.5501.02 2072.6166.02
ATSC/8VSB	R&S®SFQ02+ R&S®SFQ-B12	2072.5501.02 2072.6220.02
ISDB-T	R&S®SFQ02 + R&S®SFQ-B26	2072.5501.02 2110.0213.02
DVB-C	R&S®SFQ02+ R&S®SFQ-B21	2072.5501.02 2072.8912.02
ITU-T J.83-B	R&S®SFQ02+ R&S®SFQ-B13	2072.5501.02 2072.6243.02
DVB-S/-DSNG	R&S®SFQ02+ R&S®SFQ-B23	2072.5501.02 2072.5830.02
Broadband FM	R&S®SFQ02+ R&S®SFQ-B2	2072.5501.02 2072.6108.02

Options

Please state serial number of unit when submitting new orders for options.		
Input Interface (ASI/SPI input and selectable symbol rate, SMPTE310 input), can be retrofitted	R&S®SFQ-B6	2072.7679.03
DVB-T Coder, 2K/8K COFDM Modulator, 6 MHz/7 MHz/8 MHz bandwidth (for R&S®SFQ delivered before 1999 see R&S®SFQ-B18)	R&S®SFQ-B10	2072.6166.02
DVB-T/Hierarchical Coding	R&S®SFQ-B16	2072.5782.02
ATSC/8VSB Coder (HW + FW)	R&S®SFQ-B12	2072.6220.02
ITU-T J.83-B (FW, options R&S®SFQ-B12 and -B6 required)	R&S®SFQ-B9	2072.6143.02
ITU-T J.83-B Coder (HW + FW, option R&S®SFQ-B6 required)	R&S®SFQ-B13	2072.6243.02
ATSC/8VSB (FW, option R&S®SFQ-B13 required)	R&S®SFQ-B8	2072.6120.02
DVB-C Coder (HW + FW)	R&S®SFQ-B21	2081.8912.02
DVB-C (only FW, option R&S®SFQ-B23 required)	R&S®SFQ-B22	2072.5824.02
DVB-S/-DSNG Coder (HW + FW)	R&S®SFQ-B23	2072.5830.02
DVB-S/-DSNG (only FW, option R&S®SFQ-B21 required)	R&S®SFQ-B24	2072.5847.02
ISDB-T Coder	R&S®SFQ-B26	2110.0213.02
I/Q Output/Input	R&S®SFQ-B14	2072.6266.02
Power Supply Upgrade for R&S®SFQ model .10, delivered before 1999; serial number of R&S®SFQ must be stated	R&S®SFQ-B18	2072.7191.02
Factory-fitting of R&S®SFQ-B18 to R&S®SFQ delivered before 1999	R&S®SFQ-U11	2072.7040.02
Fading Simulator, paths 1 to 6 (for R&S®SFQ delivered before 1999 see R&S®SFQ-B18)	R&S®SFQ-B11	2072.6189.02
Fading Simulator, paths 7 to 12	R&S®SFQ-B11	2072.6189.04
Noise Generator (with internal C/N calibration)	R&S®SFQ-B5	2072.7579.03
Impulsive Noise (HW + FW, option R&S®SFQ-B5 model .04 required)	R&S®SFQ-B27	2110.0407.02
BER Measurement	R&S®SFQ-B17	2072.7056.02
Broadband FM Modulator for baseband (PAL, SECAM, NTSC) and FM sound (2 subcarriers)	R&S®SFQ-B2	2072.6108.02
2 FM Sound Subcarriers 5 MHz to 9 MHz with 2 audio generators and 2 external audio inputs	R&S®SFQ-B3	2072.7379.02
2 ADR Sound Subcarriers 0.1 MHz to 9 MHz with 2 MUSICAM generators and 1 external data input	R&S®SFQ-B4	2072.7479.02

Recommended extras

Documentation of R&S®SFQ calibration values	R&S®SFQ-DCV	2082.0490.12
Cable Set for diversity (splitter activation of the option R&S®SFQ-B5, model >.02)	R&S®SFQ-Z5	2081.9158.02
Common Interface TS OUT	R&S®SFQ-Z17	2081.9364.02
Service Kit	R&S®SFQ-Z1	2072.5960.02
Service Manual (English)		2072.6489.22
Memory Card 30 Mbyte (Flash)		2110.0371.00
19" Adapter (4 HU) for rackmounting	R&S®ZZA-94	0396.4905.00
Matching Pads 50 Ω /75 Ω , 0 GHz to 2.7 GHz, N connectors		
Matched at both ends, attenuation 5.7 dB, no DC isolation	R&S®RAM	0358.5414.02
Matched at one end, attenuation 1.7 dB	R&S®RAZ	0358.5714.02

More informationen at
www.rohde-schwarz.com
(search term: SFQ)



ROHDE & SCHWARZ

www.rohde-schwarz.com

R&S® is a registered trademark of Rohde & Schwarz GmbH & Co. KG · Trade names are trademarks of the owners · Printed in Germany (U bb)
PD 0758.0222.32 · TV Test Transmitter R&S®SFQ · Version 10.00 · June 2004 · Data without tolerance limits is not binding · Subject to change